

Geländerteile aus VA / Endkappen

stainless steel railing components / Endcaps

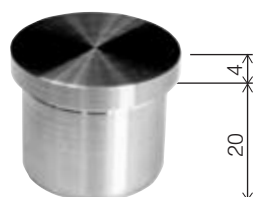

Endkappe
end caps

Drehblank flach, hohl mit Rändelung
turned flat, hollow, knurled

Art.-Nr. art. no.	Material material	Rohr Ø tube Ø
10 20 08 33	A2 304	33,7 x 2,0
10 20 08 42	A2 304	42,4 x 2,0

NEU

Endkappe
end cap

Drehblank flach, hohl
turned flat, hollow

Art.-Nr. art. no.	Material material	Rohr Ø tube Ø
8546VA4	A4 316	30 x 2,0

Endkappe
end caps

Drehblank oval, hohl mit Rändelung
turned oval, hollow, knurled

Art.-Nr. art. no.	Material material	Rohr Ø tube Ø
10 20 10 33	A2 304	33,7 x 2,0
10 20 10 42	A2 304	42,4 x 2,0

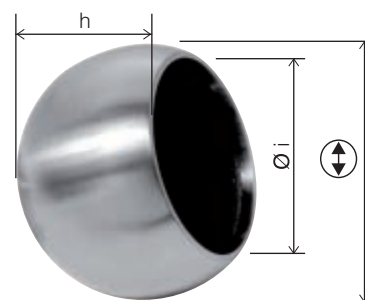

Endkappe
end caps

Drehblank rund, hohl mit Rändelung | turned round, hollow, knurled

Art.-Nr. art. no.	Material material	Rohr Ø tube Ø
10 24 21 33	A2 304	33,7 x 2,0
10 24 21 42	A2 304	42,4 x 2,0

Rohrabschlusskugel
ball end caps

Drehblank Korn 320 | turned grain 320

Art.-Nr. art. no.	Material material	h	Ø i
10 60 14 00	A2 304	33	45
10 60 09 00	A2 304	42	55

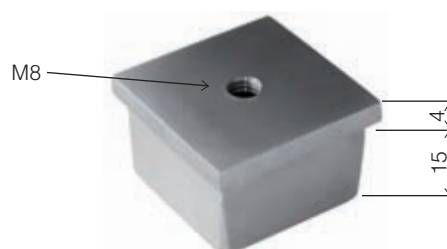
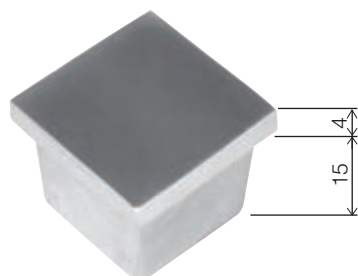

Endkappe
end caps

Flach, hohl, Korn 320 | flat, hollow, grain 320

Art.-Nr. art. no.	Material material	Rohr tube
10 30 87 00	A2 304	40 x 40 x 2,0
10 30 47 00	A4 316	40 x 40 x 2,0

Endkappe
end caps

Flach, hohl, Korn 320 | flat, hollow, grain 320

Art.-Nr. art. no.	Material material	Rohr tube
10 30 89 00	A2 304	40 x 40 x 2,0
10 31 24 00	A4 316	40 x 40 x 2,0

NEU 42,4 x 3,0



NEU 42,4 x 3,0



Endkappe end caps

Drehblank flach, massiv, mit Rändelung
turned flat, solid, knurled

Art- Nr. art. no.	Material material	Rohr Ø tube Ø	H
10 00 02 00	A2	26,9 x 2,0	10
10 00 03 00	A2	33,7 x 2,0	12
10 00 04 00	A2	42,4 x 2,0	12
10 24 40 42	A2	42,4 x 3,0	12
10 00 06 00	A2	48,3 x 2,0	12
10 55 08 00	A4	33,7 x 2,0	10
10 55 09 00	A4	42,4 x 2,0	10

Endkappe end caps

Drehblank oval, massiv, mit Rändelung
turned oval, solid, knurled

Art- Nr. art. no.	Material material	Rohr Ø tube Ø	H
10 00 07 00	A2	26,9 x 2,0	10
10 00 08 00	A2	33,7 x 2,0	12
10 00 09 00	A2	42,4 x 2,0	12
10 24 43 42	A2	42,4 x 3,0	12
10 00 11 00	A2	48,3 x 3,0	12
10 55 10 00	A4	33,7 x 2,0	10
10 55 11 00	A4	42,4 x 2,6	10



Endkappe end caps

Drehblank rund, massiv, mit Rändelung
turned round, solid, knurled

Art- Nr. art. no.	Material material	Rohr Ø tube
10 00 13 00	A2	33,7 x 2,0
10 00 14 00	A2	42,4 x 2,0

Endkappe end caps

Drehblank oval mit Lamelle, massiv
turned oval solid, with fins

Art- Nr. art. no.	Material material	Rohr Ø tube
10 00 01 00	A2	42,4 x 2,0
10 00 35 00	A2	42,4 x 2,6



Endkappe end caps

Drehblank oval, hohl
turned oval, hollow

Art- Nr. art. no.	Material material	Rohr Ø tube Ø	H
10 00 20 00	A4	33,7 x 1,5-2,6	25
10 00 21 00	A4	42,4 x 1,5-2,6	26
10 00 28 00	A4	48,3 x 2,0-2,6	26

Anschweisdeckel end caps for welding

Oval, roh
oval, rough

Art- Nr. art. no.	Material material	Rohr Ø tube Ø
10 90 03 00	A2	33,7
10 90 04 00	A2	42,4
10 90 05 00	A2	48,3
10 90 06 00	A2	60,3

Geländerteile aus VA / Endkappen

stainless steel railing components / Endcaps

NEU 42,4 x 3,0



Endkappe
end caps

Flach mit Innengewinde M8, massiv | flat with internal thread M8, solid

Art.-Nr. art. no.	Material material	Rohr Ø tube Ø
10 00 22 00	A2 304	33,7 x 2,0
10 00 23 00	A2 304	42,4 x 2,0
10 24 41 42	A2 304	42,4 x 3,0
10 55 05 00	A4 316	42,4 x 2,0

NEU 42,4 x 3,0

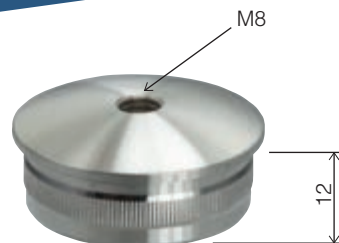

Endkappe
end caps

Oval mit Innengewinde M8, massiv
oval with internal thread M8, solid

Art.-Nr. art. no.	Material material	Rohr Ø tube Ø
10 00 24 00	A2 304	33,7 x 2,0
10 00 25 00	A2 304	42,4 x 2,0
10 00 36 00*	A2 304	42,4 x 2,6
10 24 42 42	A2 304	42,4 x 3,0

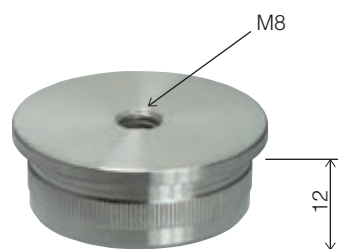

Endkappe
end caps

Flach mit Innengewinde M8, hohl | flat with internal thread M8, hollow

Art.-Nr. art. no.	Material material	Rohr Ø tube Ø
10 20 46 33	A2 304	33,7 x 2,0
10 20 46 42	A2 304	42,4 x 2,0
10 24 12 42	A2 304	42,4 x 2,6

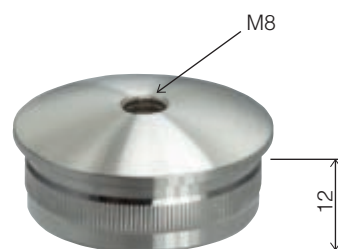

Endkappe
end caps

Oval mit Innengewinde M8, hohl
oval with internal thread M8, hollow

Art.-Nr. art. no.	Material material	Rohr Ø tube Ø
10 20 48 42	A2 304	42,4 x 2,0



NEU

Endkappe
end caps

Aufnahme für Handlaufträger, höhenverstellbar
adapter for handrail support, height adjustable

Art.-Nr. art. no.	Material material	Rohr Ø tube Ø
10 24 55 42	A2 304	42,4 x 2,0

