

# DM

## GELÄNDERPFOSTEN BALUSTRADE POSTS

Die neue Generation Brüstungen  
the new generation of balustrades



**DEUTSCHE  
METALL**®

# Geländerpfosten

balustrade posts



- Sicherheit durch abP bis Anpralllasten von 1,0 kN
  - vergüteter Flachstahl feuerverzinkt und pulverbeschichtet
  - sehr filigrane Gesamtoptik (Querschnitt 12 x 60 mm)
  - großzügige Pfostenabstände ermöglichen Glasbreiten bis 3800 mm
  - Endlosmontage ohne weitere Aussteifung in den Ecken möglich
  - günstiger Glasaufbau (12,76 mm)
  - Kantenschutz vor Nässe und Stoß mit durchgehendem U-Profil aus Edelstahl
  - zweiseitig linienförmig gelagerte Verglasung nach DIN 18008
  - schnelle Glasmontage durch obere Klemmfixierung der Scheibe
  - sicher geführte Glasmontage durch feste Nut am Fuß des Pfostens
  - schmale Glasfugen von 10 mm bieten eine höhere Winddichtigkeit
  - für Aufsatz- und Vorsatzmontage geeignet
- safety with abP and beam loads up to 1.0 kN
  - galvanized and powder-coated flat steel
  - filigree appearance (cross section 12 x 60 mm)
  - large post spacing allows glass widths up to 3800 mm
  - finite assembly without further bracing in the corners possible
  - favorable glass thickness (12,76 mm)
  - edge protection against moisture and impact with continuous U-profile made of stainless steel
  - two-sided linear glazing according to DIN 18008
  - quick glass installation due to upper clamping fixation of the panel
  - secure glass mounting due to fixed slot at the base of the post
  - narrow glass butts of 10 mm provide higher wind reduction
  - suitable for floor and front mounting

abP = german national technical certification

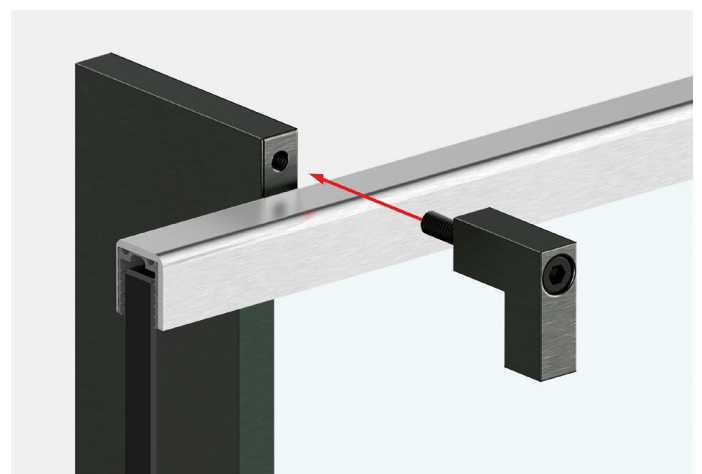

Die obere Klemmfixierung wird angeschraubt. Die Klemmung des U-Profil kann durch die im Pfosten eingebaute Madenschraube variiert werden.

The upper clamp is attached with screws. The clamping of the u-profile can be varied by the grub screw installed in the post.

Prüfzeugnisse erhalten neue Nummern, wenn sie verlängert, d. h. erneuert werden. Wenden Sie sich in solchen Fällen an uns, um Informationen zu erhalten.  
Test certificates become new numbers when renewed. In these cases contact us for information.

# Geländerpfosten

balustrade posts

Scheibenaufbau = VSG aus 6mm ESG / ESG-HF, 0,76mm PVB

glass composition = LSG of 6mm FTG / FTG-HF, 0,76mm PVB



Abmessung Geländersystem mit 2 Pfosten

dimensions for balustrade system with 2 posts

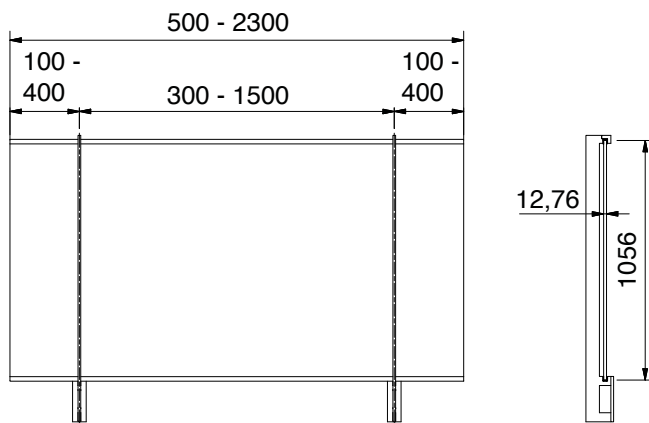

Abmessung Geländersystem mit 3 Pfosten

dimensions for balustrade system with 3 posts

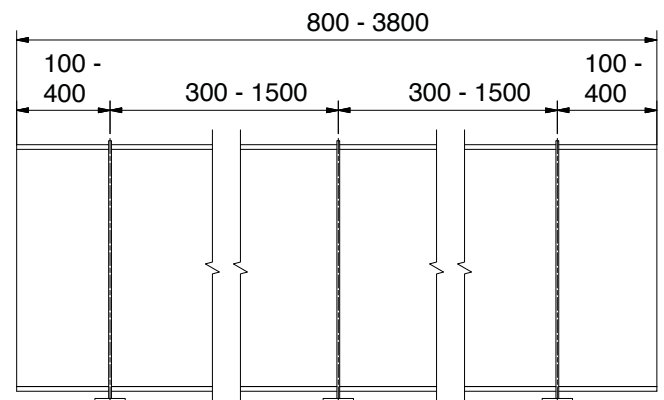
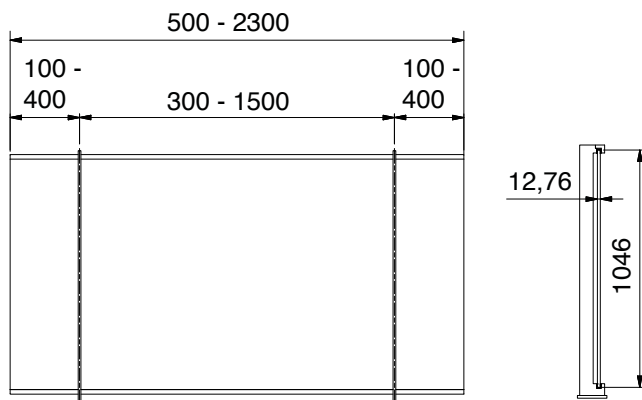
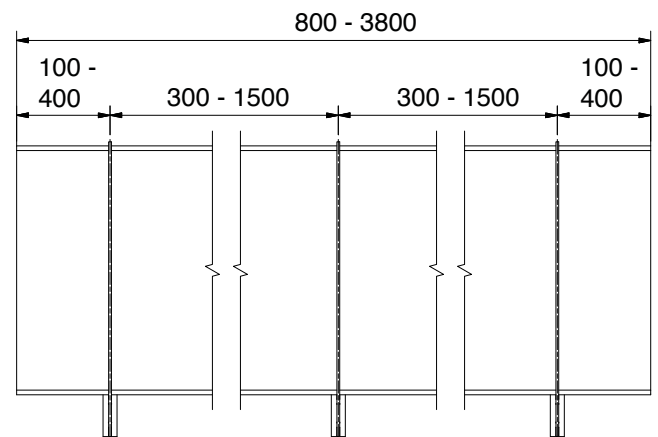

Prüfzeugnisse erhalten neue Nummern, wenn sie verlängert, d. h. erneuert werden. Wenden Sie sich in solchen Fällen an uns, um Informationen zu erhalten.  
Test certificates become new numbers when renewed. In these cases contact us for information.

Scheibenaufbau für Treppen = VSG aus 6mm ESG / ESG-HF, 0,76mm PVB

glass composition for stairs = LSG of 6mm FTG / FTG-HF, 0,76mm PVB

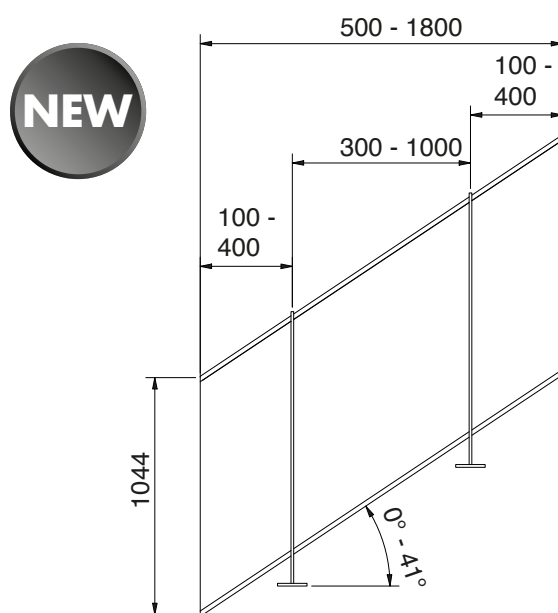
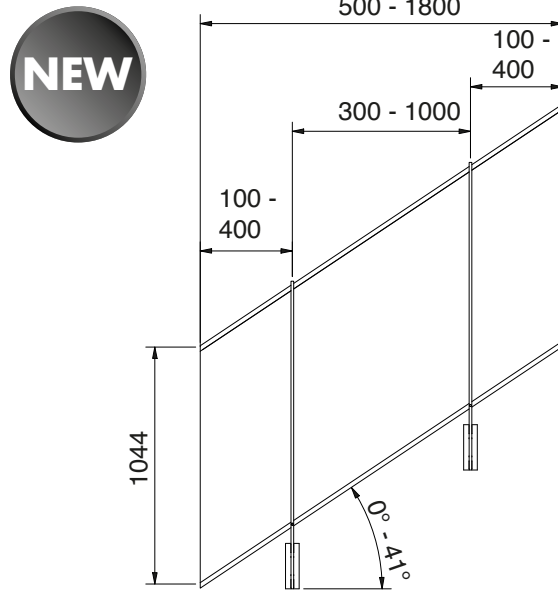

# Geländerpfosten

balustrade posts



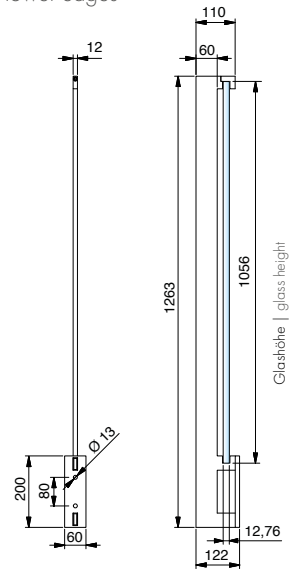
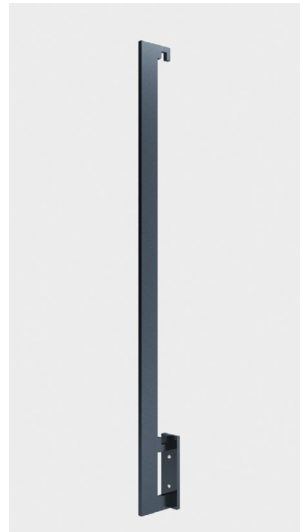

## Geländerpfosten – mit U-Profil oben / U-Profil unten

balustrade posts with U-profiles on the upper and lower edges



### Einzelpfosten für Frontmontage | single post for fascia mounting

Oberfläche: RAL pulverbeschichtet  
surface: RAL powder coated

Art.-Nr. art.-no.	Material material	Sicherheit safety		
10244912RAL7016	Stahl verzinkt steel, zinc galvanised		12,76	VSG aus ESG LSG of FTG

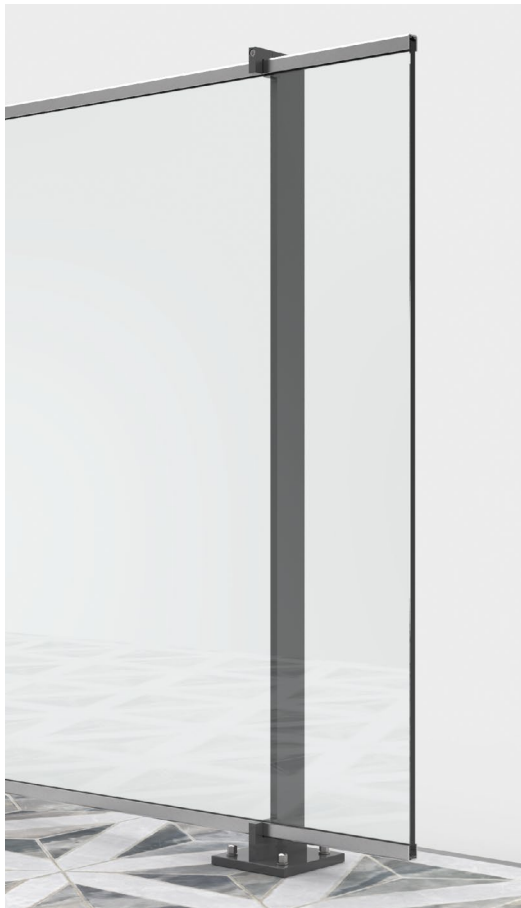

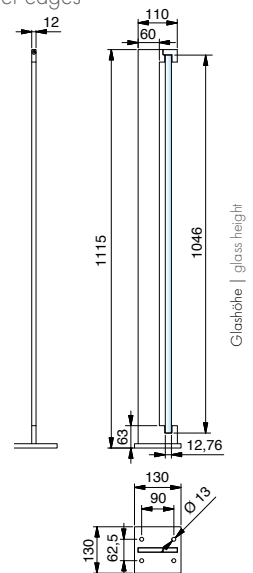
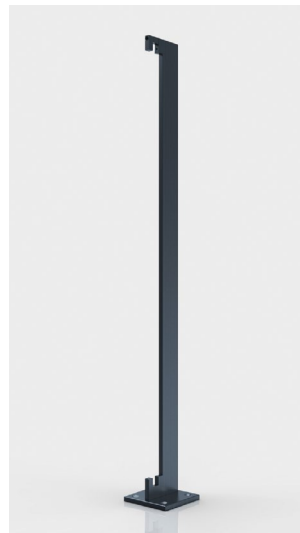

## Geländerpfosten - mit U-Profil oben / U-Profil unten

balustrade posts with U-profiles on the upper and lower edges



### Einzelpfosten für Aufsatzmontage | single post for floor mounting

Oberfläche: RAL pulverbeschichtet  
surface: RAL powder coated

Art.-Nr. Art.-no.	Material material	Sicherheit safety		
10244812RAL7016	Stahl verzinkt steel, zinc galvanised		12,76	VSG aus ESG LSG of FTG



## Geländerpfosten für Treppenanschluss – mit U-Profil oben / U-Profil unten

balustrade posts with U-profiles on the upper and lower edges

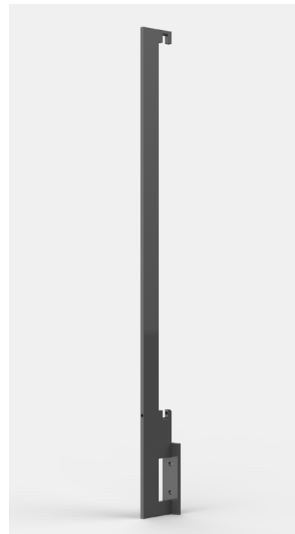

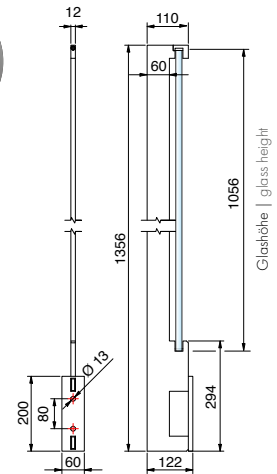

**NEW**



### Treppen-Einzelpfosten für Frontmontage | single post for fascia mounting

Oberfläche: RAL pulverbeschichtet  
surface: RAL powder coated

Art.-Nr. art.-no.	Material material	Sicherheit safety		
10247812RAL7016	Stahl verzinkt steel, zinc galvanised		12,76	VSG aus ESG LSG of FTG

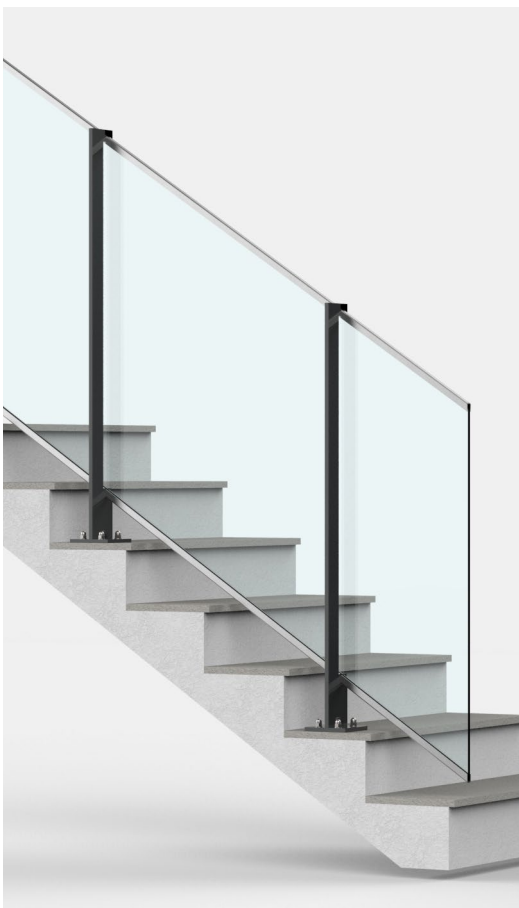

## Geländerpfosten für Treppenanschluss - mit U-Profil oben / U-Profil unten

balustrade posts with U-profiles on the upper and lower edges

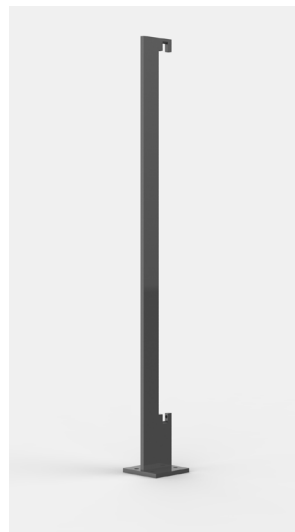

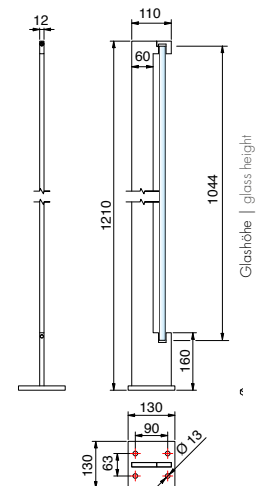

**NEW**



### Treppen-Einzelpfosten für Aufsatzmontage | single post for floor mounting

Oberfläche: RAL pulverbeschichtet  
surface: RAL powder coated

Art.-Nr. Art.-no.	Material material	Sicherheit safety		
10247712RAL7016	Stahl verzinkt steel, zinc galvanised		12,76	VSG aus ESG LSG of FTG

# Geländerpfosten

balustrade posts



## U-Profil und Gummiprofil | U-profile and elastomer profile

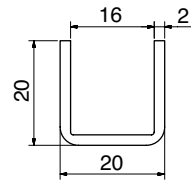

5020VA2-5M/-2500

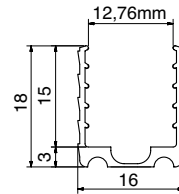

10245320KU-5M

### U-Profil | U-profile

Oberfläche: geschliffen  
surface: brushed

Art.-Nr. art.-no.	Material material		Länge length	Oberfläche surface
5020VA2-2500	A2   304	12,76	2500	Korn   grain 320
5020VA2-5M	A2   304	12,76	5000	Korn   grain 320
10245320KU-5M	Elastomer	12,76	5000	-







Notizen | notes

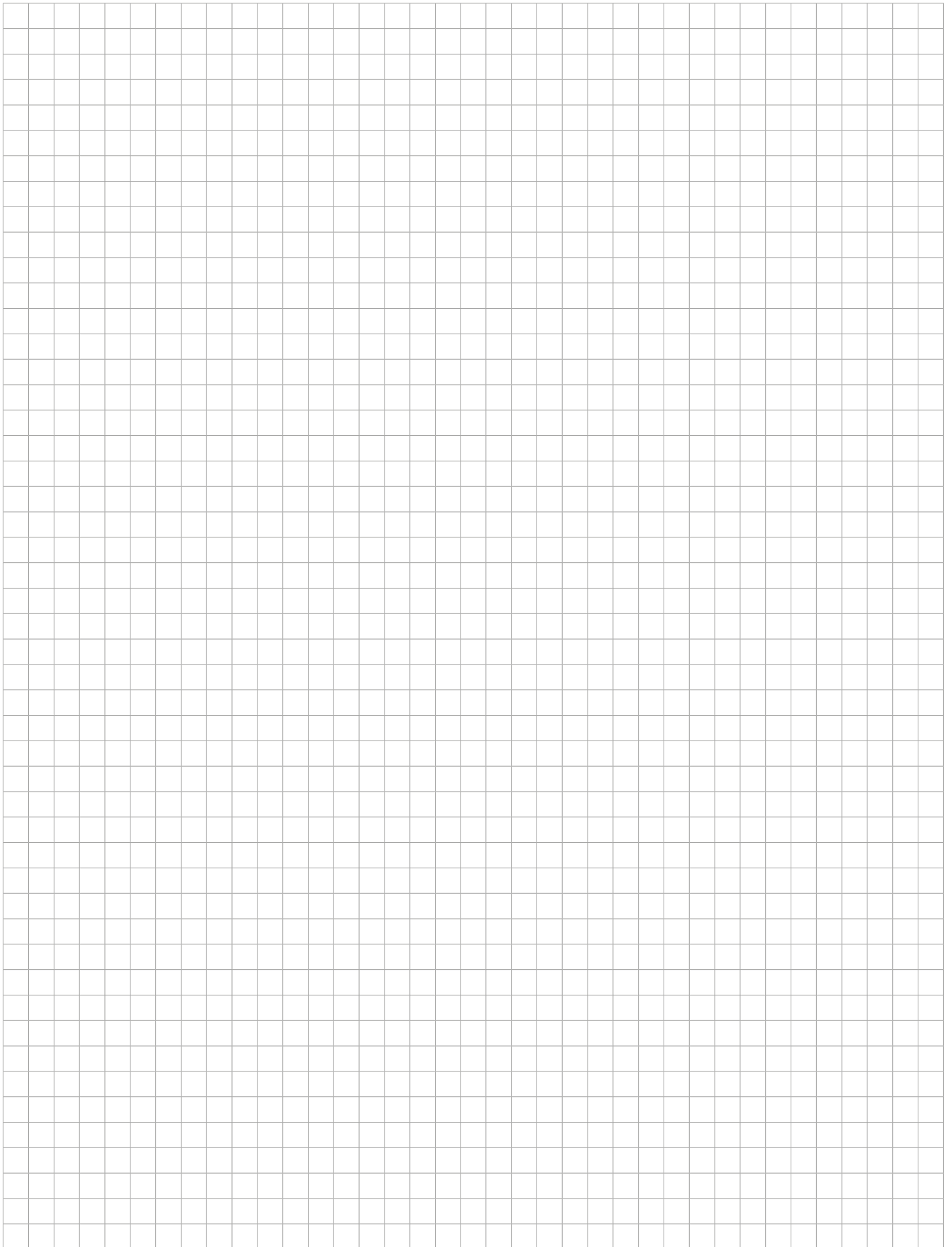

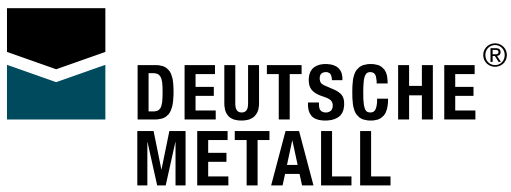

Zentrale / Abholermarkt Mannheim  
Boehringerstraße 2a  
D-68307 Mannheim  
Telefon: +49 (0) 621-39 72 42-0  
Fax: +49 (0) 621-39 72 42-20

[www.deutschemetall.de](http://www.deutschemetall.de)  
[verkauf@deutschemetall.de](mailto:verkauf@deutschemetall.de)

Artikel: 99000130DM  
Geländerpfosten DM 2024